

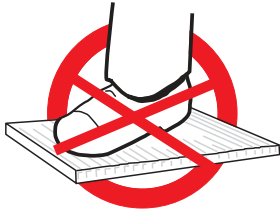

Sole Australian distributor of Lexan* Multiwall sheeting



NOTE:
Please read instructions thoroughly prior to commencement of installation

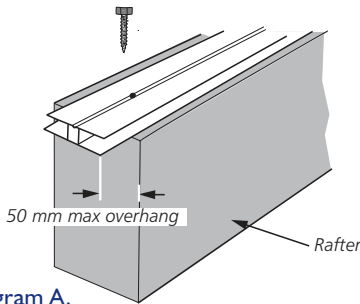

Diagram A.



H-Bar Installation Instructions

Lexan* Thermoclear* Twinwall & Multiwall

*Trademarks of Sabic Innovative Plastics IP BV

Site safety. In all applications, sheeting should not be used to support a person's weight during installation or cleaning. A temporary wooden beam or other device, supported by roof members, should always be used.

Design considerations:

For new structures, attempt to design in accordance with the following table.

10 mm Twin Wall sheet

Sheet width	Rafter spacing (Centres)	Purlin (Batten) spacing	Min. fall
700 mm	720 mm	not required	5°
1050 mm	1070 mm	not required	5°

Above figures based on 1.5 kPa. For installation in high wind areas, please contact Ampelite.

For existing structures or designs outside of the above table, sheets will need to be cut to width to ensure that rafters support the H-Bar.

For the best final appearance of the structure, the roof battens should be housed into the rafters so that the rafters and battens are on the same plane. The H-Bars are then screwed to the rafters as Diagram A.

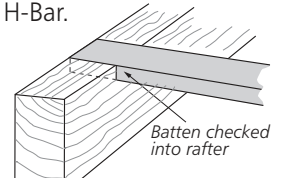

Allow overhang (maximum 50 mm) if draining into gutter. (Diagram A)

Installation Hints:

Both sides of the sheet are UV protected and can therefore be installed with either side facing up.

Sheet ribs (flutes) must run vertically with the fall of the structure.

Sheeting can be cut to length using a power saw fitted with a fine tooth blade of a type suitable for plastic. A sharp blade can be used for cutting to width.

The **End Cap Gasket** is easily identifiable as it is a heavier gauge than the **H-Bar Gasket**.

Do not use sealants that are not 100% chemically compatible with polycarbonate sheeting; suitable sealants are available from Ampelite. The use of incorrect sealants or gaskets will void the warranty.

For installation in curved applications, please contact Ampelite.

Checklist:

- Lexan® Thermoclear® Sheeting
- Aluminium H-Bar
- H-Bar Gasket
- Aluminium End Cap ('U' shaped)
- End Cap Gasket
- Aluminium Sealer Tape
- Aluminium Breather Tape
- Anti-noise Tape
- 12 gauge Screws (minimum)
- Bonded Washers
- Ezy-Glide Lubricant Spray (if required)

SABIC
Innovative
Plastics™



Authorized Distributor



*Trademark of Sabic Innovative Plastics IP BV

Installation:

1.

Check structure and sheet measurements.

2.

Peel back protective film approximately 50 mm on all edges of sheet(s) see inset **diagram B**. Clear flutes in sheeting using vacuum cleaner or compressed air gun. Peel backing from Aluminium Sealer Tape and apply carefully to ridge ends of sheet to seal flutes. Peel backing from Aluminium Breather Tape and apply carefully to gutter end of sheet.

3.

Place Anti-noise tape on battens to prevent excessive noise caused by expansion and contraction of the sheeting.

4.

Drill small oval "weep" hole on lower end (underside centre) of the first measured and cut H-Bar section to allow for water drainage. Refer to **diagram D**.

5.

Place H-Bar on rafter (or other support) with grooved side facing up. Secure through groove with 12 gauge screws compatible with framing material (maximum spacing 600 mm). See **diagram A**. It is recommended to start and finish a run with a H-Bar. Use one continuous length of H-Bar rubber per side to avoid leakage.

6.

Apply H-Bar Gasket to entire length of sheet (**diagram C**) and push sheet into the already secured H-Bar as diagram D. A rubber mallet may be used to tap sheet with gasket applied into the H-Bar. For ease of installation of long sheets, 'Ezy-Glide' spray may need to be applied to the gasket.

7.

Apply H-Bar Gasket to the other side of sheet. Push next H-Bar section onto sheet and fix into position. Continue until all sheets are fixed. The void side of the two outer H-Bars can be filled with the H-Bar finishing gasket.

8.

Place End Cap Gasket over Sealer Tape and Breather Tape at ends of sheets, stopping at H-Bar sections. See **diagram D**.

9.

Push Aluminium End Cap over the entire width of Twin Wall structure, covering both the Gasket and H-Bar. **Diagram E**.

10.

Fasten Aluminium End Cap through H-Bar using a single screw at every rafter. A small oval "weep" hole may need to be drilled near the edge of the Aluminium End Cap. **Diagram F**.

11.

Carefully remove protective film from all sheets.

12.

To prevent excessive deflection, sheets will require additional fixings on the battens/purlins. For 700 mm width sheets drill an 11 mm (oversized) hole through the mid point of the sheet and secure to batten/purlin using a single screw with bonded washer. The 1050 mm width sheets will require two fixings at even spacings across each batten/purlin.

Cleaning of multiwall sheeting

Please refer to site safety instructions on front page before cleaning.

Rinse sheet with lukewarm water.

Wash sheet with a solution of mild soap or household detergent and lukewarm water, using a soft cloth or sponge to loosen any dirt and grime.

Rinse off with cold water and dry with soft cloth to avoid spotting.

Note: Never use an abrasive or highly alkaline cleaner on sheet. If you are unsure as to what cleaning agents can be used, please contact Ampelite.

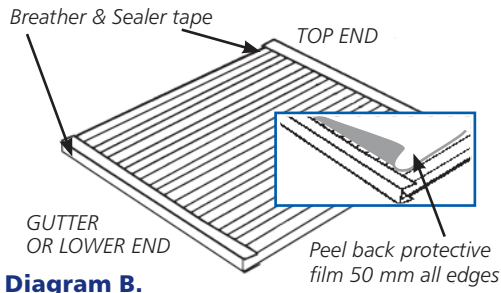

Diagram B.

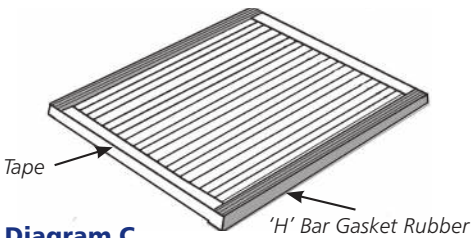

Diagram C.

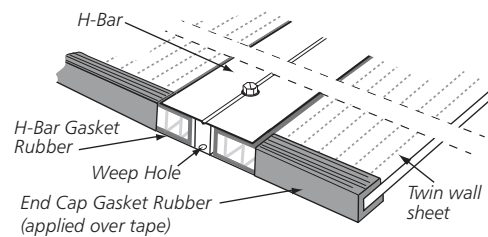

Diagram D.

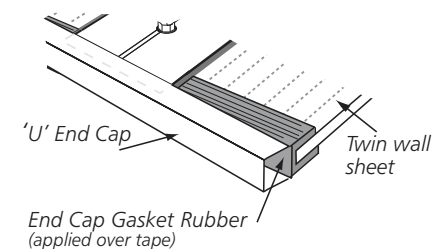

Diagram E.

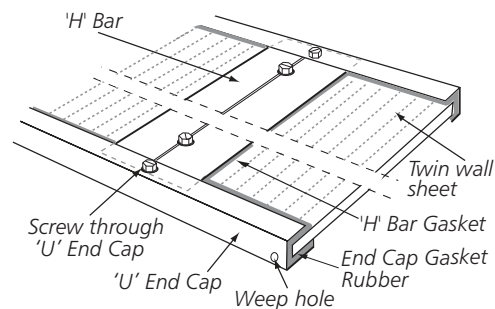

Diagram F.